



NM1 Interruptores en Caja Moldeada

1. General

- 1.1 Certificados: KEMA, RCC, GOST, ESC, UKrSEPRO, EK;
- 1.2 Tensión nominal: 690Vca, 50/60HZ,
- 1.3 Corrientes nominales: 10~1250A;
- 1.4 Modo de montaje: Vertical y horizontal;
- 1.5 Estándar: UNE-EN60947-2.

	Países Bajos	
	Rep. Checa	
	Ucrania	
	Rusia	
	Sud Africa	
	Corea	

2. Modelo

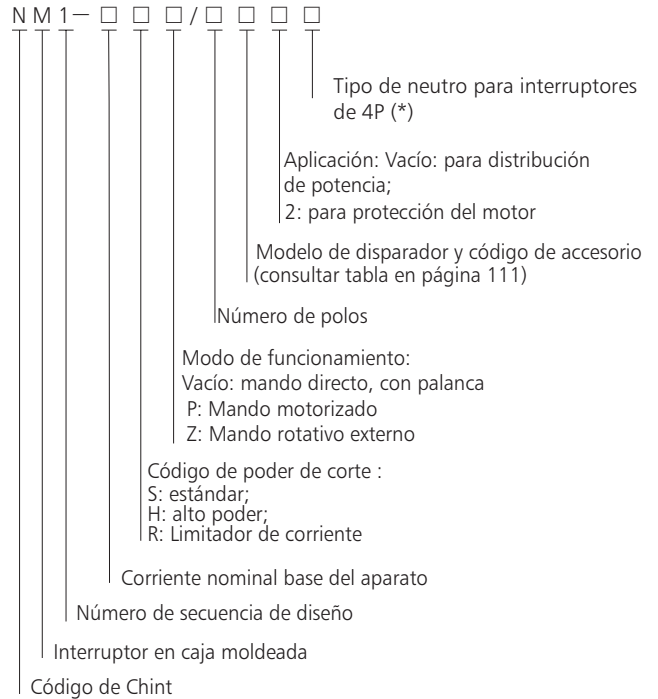

Nota *: Hay 4 tipos de Neutro para los interruptores de 4P A: Sin bloque de relés de protección - el neutro está siempre conectado, no se conecta y desconecta con los otros tres polos; B: Sin bloque de relés de protección - el neutro se conecta con los otros tres polos (desconecta antes y conecta después de las fases); C: Con bloque de relés de protección - el neutro se conecta con los otros tres polos (desconecta antes y conecta después de las fases); D: Con bloque de relés de protección - el neutro está siempre conectado, no se conecta y desconecta con los otros tres polos.

3. Clasificación

Según el poder de corte del interruptor:

Estándar (S)



Alto poder de corte (H)

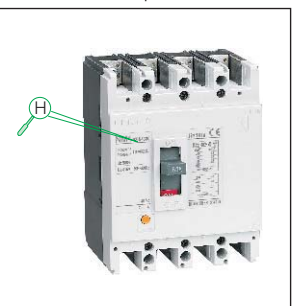

Llimitador de corriente (R)



Según el sistema de conexión:

Conexión frontal



Conexión posterior



Conexión enchufable



Según el modo de funcionamiento:

Funcionamiento directo con palanca



Funcionamiento con mando rotativo



Funcionamiento motorizado



Según el número de polos:

2P



3P



4P



4. Condiciones de trabajo

4.1 Temperatura: $-5^{\circ}\text{C} \sim +40^{\circ}\text{C}$; el valor medio en 24h no debe superar los $+35^{\circ}\text{C}$ (consulte los coeficientes en P70 para la compensación por temperatura ambiente). Para interruptores magnetotérmicos la temperatura de calibración es $+40^{\circ}\text{C}$. Para temperaturas entre $-5^{\circ}\text{C} \sim +40^{\circ}\text{C}$, contactar con Chint para consultar la corrección idónea.

4.2 Altitud: no superior a 2000m (contacte con Chint para consultar el coeficiente si la altitud del lugar de instalación supera los 2000m)

4.3 Grado de contaminación: Grado 3.

4.4 Condiciones ambientales

En el lugar de la instalación, la humedad relativa no debe superar el 50% a una temperatura máxima de $+40^{\circ}\text{C}$, sin embargo una humedad relativa superior es permisible bajo temperaturas inferiores. Por ejemplo, puede ser del 90% a $+20^{\circ}\text{C}$, debiéndose de tomar medidas especiales en caso de condensación.

8. Curvas de disparo (calibradas a 40°C)

8.1 Curvas

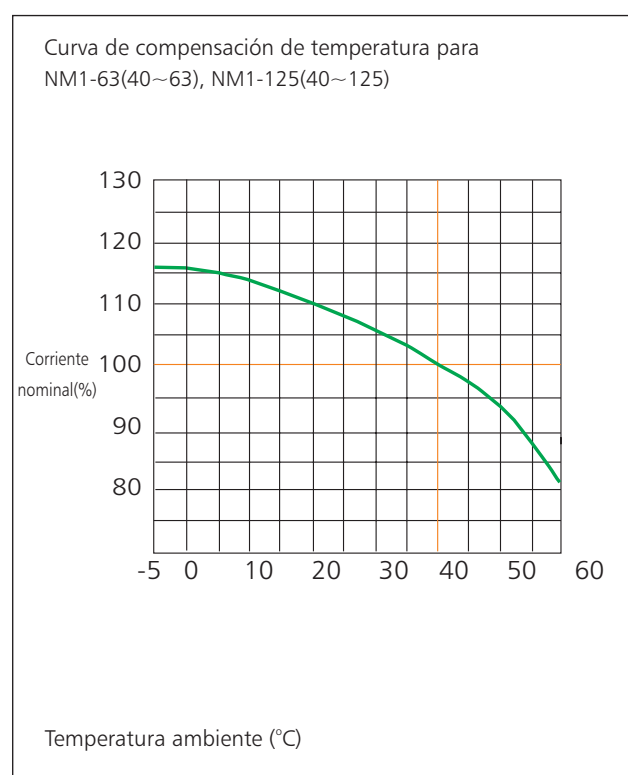
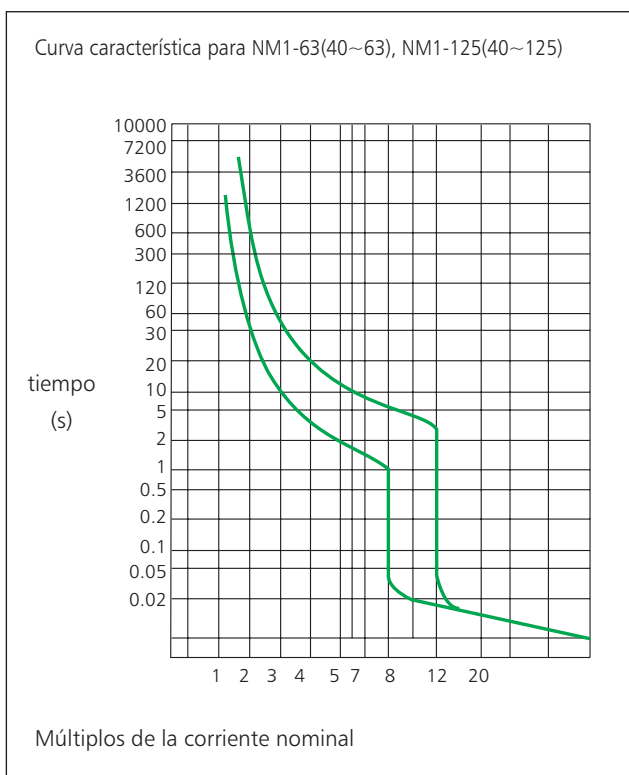
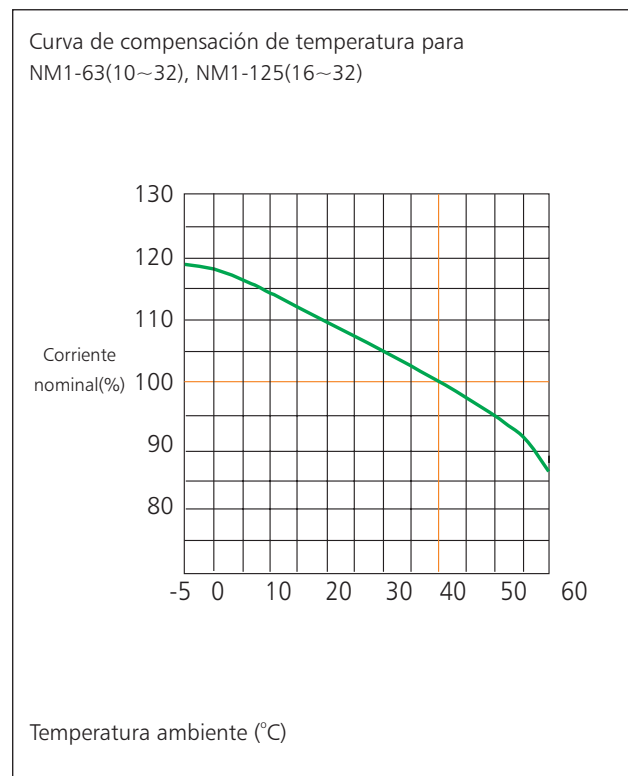
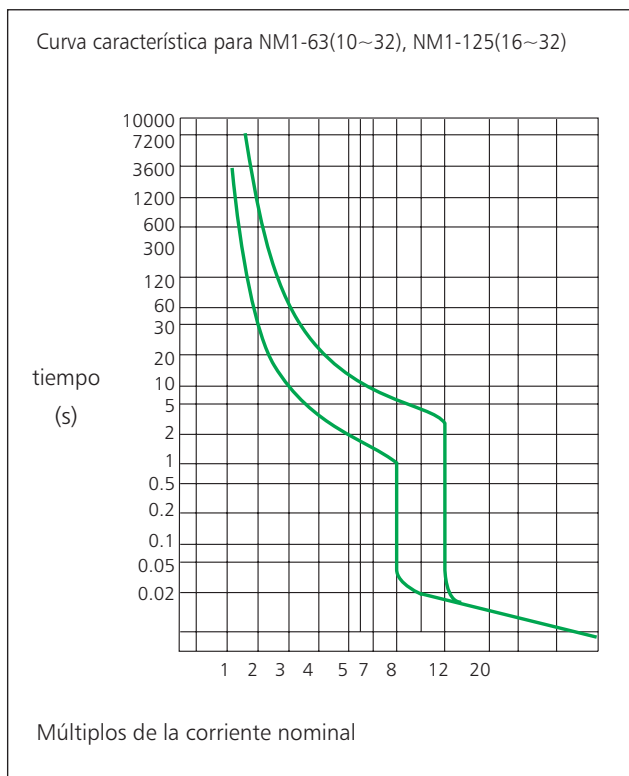

5. Características técnicas

Corriente base de los interruptores	63				125				250				400				630				800				1250																		
Características eléctricas según UNE-EN60947-2																																											
Corriente nominal (A) In 40°C	10, 16, 20, 25, 30, 32, 40, 50, 60, 63				16, 20, 25, 30, 32, 40, 50, 60, 63, 75, 80, 100, 125				100, 125, 140, 150, 160, 175, 180, 200, 225, 250				225, 250, 300, 315, 350, 400				400, 500, 630				630, 700, 800				700, 800, 900, 1000, 1250																		
Tensión nominal de aislamiento Ui (V)	500				800				800				800				800				800				800																		
Impulso de tensión máximo al choque (V) Uimp	6				8				8				8				8				8				8																		
Tensión nominal de servicio (V) Ue AC 50/60Hz	415				690				690				690				690				690				690																		
Distancia de formación de arco (mm)	≤50				≤50				≤50				≤100				≤100				≤100				≤100																		
Código de poder de corte	S		H		C		S		H		R		C		S		H		R		S		H		R		S		H		R		S		H		R		H		R		H



Polos	2	3	3	4	2	3	4	2	3	4	2	3	4	2	3	4	2	3	4	1	2	3	4	2	3	4	2	3	4	3	4	3	4	3	4	3	4	3	4	3	4	3	4	3	4	3	4	3	4	3						
Poder de corte último en cortocircuito	220/230/240Vca		20	20	42	42	25	25	25	42	42	42	65	65	65	85	85	85	25	25	25	20	42	42	42	65	65	65	85	85	85	50	50	85	85	100	100	50	50	85	85	100	100	85	85	100	100	85	85	100	100	85	85	100	100	85
Icu (kA, RMS)	380/400/415Vca		15	15	35	35	20	20	20	25	25	25	50	50	50	65	65	65	20	20	20	-	25	25	25	50	50	50	65	65	65	35	35	50	50	70	70	35	35	50	50	70	70	60	60	70	70	60	60	70	70	65	65	70	70	65
Secuencia de prueba: O-t-CO	660/690Vca		-	-	-	-	-	3	3	-	3	3	-	8	8	-	10	10	-	5	5	-	-	5	5	-	8	8	-	10	10	10	10	12	12	15	15	12	12	15	15	20	20	20	20	20	20	20	20	20	20	20				
Poder de corte de servicio en cortocircuito Ics (kA, RMS)	50%																																																							
Secuencia de prueba: O-t-CO-t-CO	50%																																																							
Adecuado para aislamiento	■				■				■				■				■				■				■				■																											
Categoría de utilización	A				A				A				A				A				A				A																															
Conexión frontal	■				■				■				■				■				■				■																															
Conexión posterior	■				■				■				■				■				■				■																															
Conexión enchufable	■				■				■				■				■				■				■																															
Bobina de emisión de corriente	■				■				■				■				■				■				■																															
Bobina de mínima tensión	■				■				■				■				■				■				■																															
Contacto auxiliar	■				■				■				■				■				■				■																															
Contacto de alarma	■				■				■				■				■				■				■																															

Nota: ① Para aparatos de 63H hasta 800H existen versiones con formación de arco cero (excepto 800H/4P)
 ② Los símbolos O-t-Co, O-t-Co-t-Co se utilizan para definir la secuencia de operaciones.
 O: corte; t: intervalo de tiempo entre dos cortocircuitos sucesivos; CO: conexión inmediata; tras pasar el tiempo de apertura necesario, retorno a situación de corte.

6. Relé magnetotérmico

Apertura en tiempo inverso en caso de disparo del interruptor por sobrecorriente (para distribuciones de potencia) en las situaciones en que todos los polos hayan sido alimentados simultáneamente.

Secuencia	Comprobación de la corriente	I/In	Tiempo convencional	Estado inicial
1	Corriente sin disparo convencional	1.05	2h(In>63A), 1h(In≤63A)	Estado en frío
2	Corriente con disparo convencional	1.30	2h(In>63A), 1h(In≤63A)	Justo después de la sec. nº 1

Apertura en retardo de tiempo inverso en caso de disparo del interruptor por sobrecorriente (para protecciones de motor) en las situaciones en que todos los polos hayan sido alimentados simultáneamente (según UNE-EN60947-3).

Secuencia	Ajuste de corriente	Tiempo convencional	Estado inicial	Notas
1	1.0In	>2h	Estado frío	
2	1.2In	≤2h	Justo después de prueba nº 1	
3	1.5In	≤4min	Estado frío	10≤In≤225
		≤8min	Estado frío	225≤In≤630
4	7.2In	4s≤t≤10s	Estado frío	10≤In≤225
		6s≤t≤20s	Estado frío	225≤In≤630

El neutro del interruptor 4P se encuentra en el lado derecho del mismo. Consultar la corriente nominal del disparador del neutro, en caso de los tipos C y D en la siguiente tabla:

Corriente base del aparato (A)	Corriente nominal (A)	Corriente nominal del neutro (A)
63	10	10
	16	16
	20	20
	25	25
	30	30
	32	32
	40	40
	50	50
125	60	60
	63	63
	16	16
	20	20
	25	25
	30	30
	32	32
	40	40
250	50	50
	60	60
	63	63
	75	63
	80	63
	100	63
	125	63
	125	63

Corriente base del aparato (A)	Corriente nominal (A)	Corriente nominal del neutro (A)
250	100	100
	125	100
	140	100
	150	100
	160	100
	175	100
	180	100
	200	100
400	225	125
	250	125
	225	225
	250	225
	300	225
	315	225
	350	225
	400	225
630	400	400
	500	400
	630	400
	630	500
800	700	500
	800	500
	800	500

Nota: Bajo demanda pueden suministrarse aparatos con la corriente admisible en el neutro igual que la de las fases.

7. Despiece del interruptor

Interruptor en Caja Moldeada serie NM1

- 1 Interruptor (tipo fijo)
- 2 Tipo enchufable
- 3 Conexión posterior
- 4 Bobina de mínima tensión
- 5 Bobina de emisión de corriente
- 6 Contacto de alarma
- 7 Contacto auxiliar
- 8 Accionamiento motorizado
- 9 Mando manual con eje prolongado
- 10 Bloqueo mecánico
- 11 Terminal para cable (ver Pag.102)
- 12 Cubrebomes
- 13 Pletina para conexión frontal

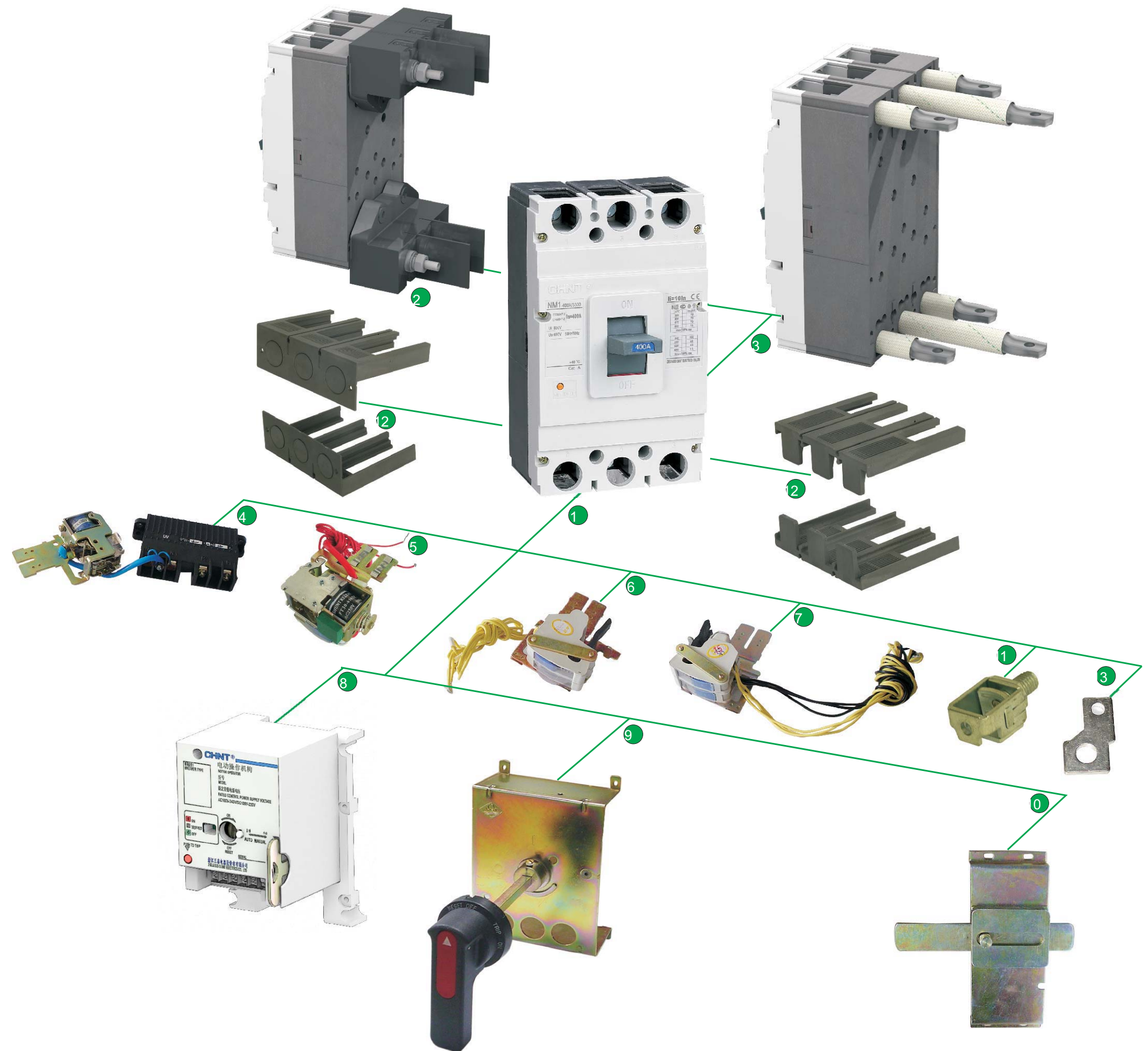

Curva característica para NM1-250

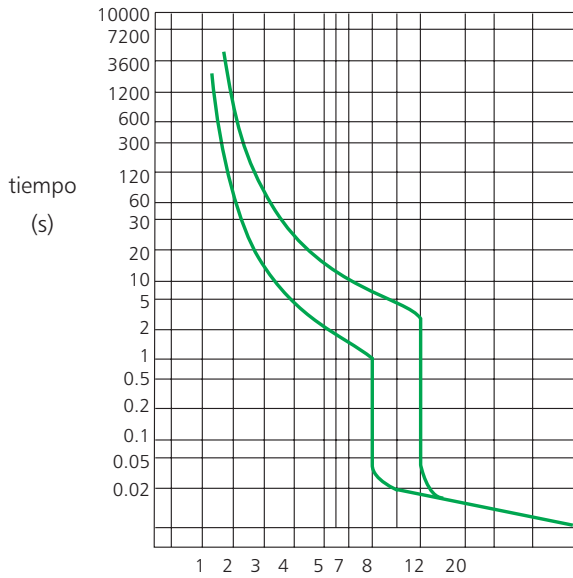

Múltiplos de la corriente nominal

Curva de compensación de temperatura para NM1-250

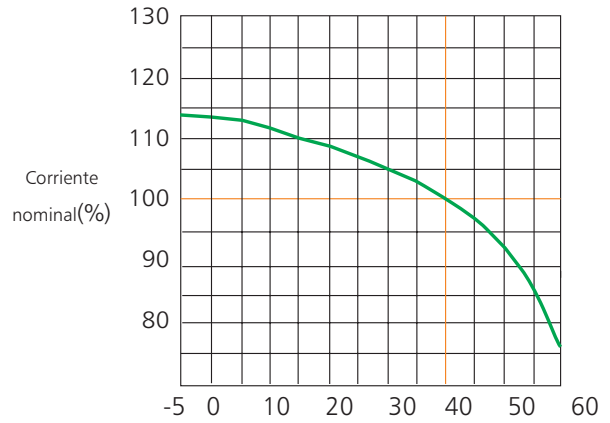

Temperatura ambiente (°C)

Curva característica para NM1-400

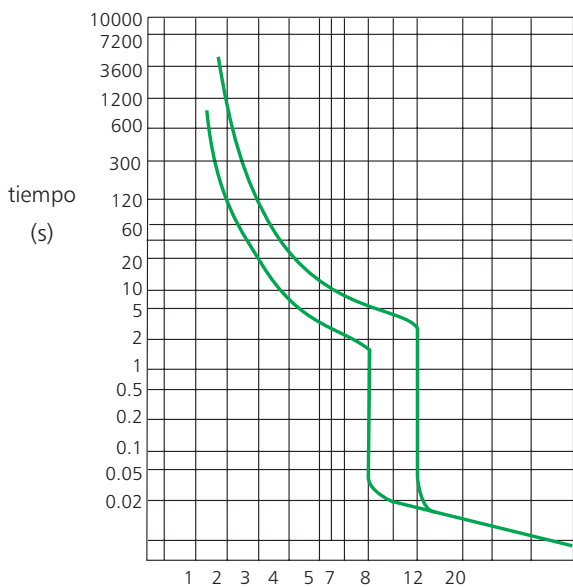

Múltiplos de la corriente nominal

Curva de compensación de temperatura para NM1-400

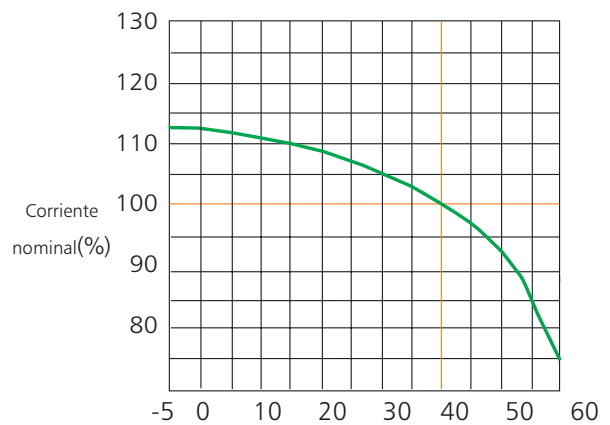

Temperatura ambiente (°C)

Curva característica para NM1-630, 800

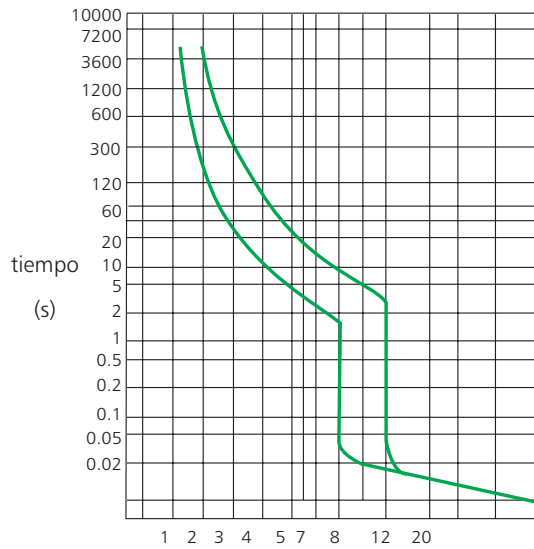

Múltiplos de la corriente nominal

Curva de compensación de temperatura para NM1-630, 800

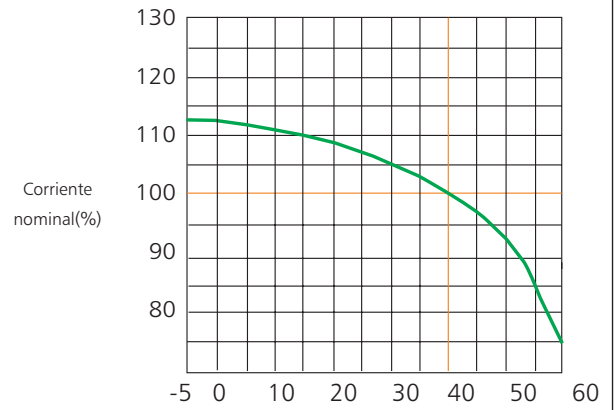

Temperatura ambiente (°C)

Curva característica para NM1-1250

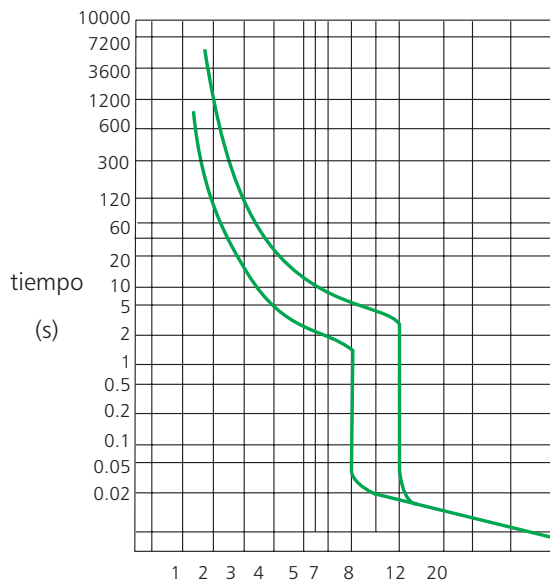

Múltiplos de la corriente nominal

Curva de compensación de temperatura para NM1-1250

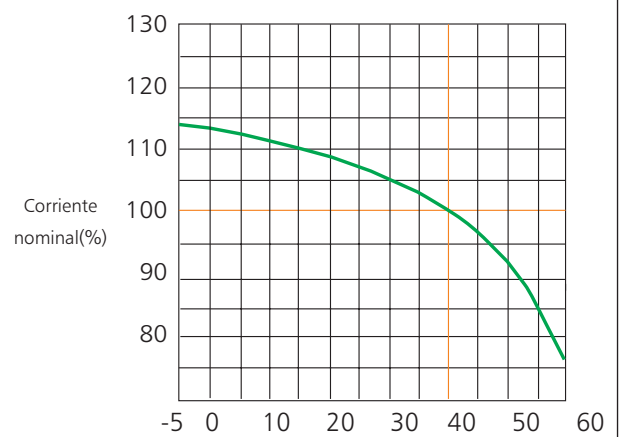

Temperatura ambiente (°C)

8.2 Coeficientes de corrección para compensación de la temperatura

Tabla de coeficientes para interruptores NM1 (calibración estándar: 40°C, para calibración a otras temperaturas contactar con Chint)

Modelo	Rango de corriente	Coeficiente de compensación													
		-5°C	0°C	5°C	10°C	15°C	20°C	25°C	30°C	35°C	40°C	45°C	50°C	55°C	60°C
NM1-63S, H	10~32A	1.18	1.17	1.16	1.14	1.12	1.09	1.07	1.05	1.03	1	0.97	0.95	0.92	0.87
NM1-63S, H	40~63A	1.16	1.16	1.15	1.14	1.12	1.10	1.08	1.06	1.03	1	0.97	0.94	0.87	0.82
NM1-125C, S, H, R	16~32A	1.18	1.17	1.16	1.14	1.12	1.09	1.07	1.05	1.03	1	0.97	0.95	0.92	0.87
NM1-125C, S, H, R	40~100A	1.16	1.16	1.15	1.14	1.12	1.10	1.08	1.06	1.03	1	0.97	0.94	0.87	0.82
NM1-250C, S, H, R	100~225A	1.14	1.13	1.13	1.12	1.10	1.08	1.07	1.05	1.03	1	0.97	0.93	0.86	0.76
NM1-400S, H, R	225~400A	1.13	1.12	1.12	1.11	1.10	1.08	1.06	1.05	1.03	1	0.97	0.93	0.85	0.75
NM1-630S, H, R	400~630A	1.13	1.12	1.12	1.11	1.10	1.08	1.07	1.05	1.03	1	0.97	0.93	0.85	0.75
NM1-800S, H, R	630~800A	1.13	1.12	1.12	1.11	1.10	1.08	1.07	1.05	1.03	1	0.97	0.93	0.85	0.75
NM1-1250H	700~1250A	1.14	1.13	1.12	1.11	1.10	1.09	1.07	1.05	1.03	1	0.97	0.92	0.85	0.76

9. Conexiones

Conexión frontal (Conexión fija)

Terminales de conexión (para aparatos de 10 a 1250A existen terminales prolongados)

Tornillos de conexión



Calibre base del aparato	Corriente (A)	Código de poder de corte	Conexión frontal		
			Tornillo hexagonal (B)	Tornillo hexagonal (A)	Tornillo de cruz (C)
63	10	S	■		
		H	■		
	16	S	■		
		H	■		
	20	S	■		
		H	■		
	25	S	■		
		H	■		
	30	S	■		
		H	■		
	32	S	■		
		H	■		
	40	S	■		
		H	■		
	50	S	■		
		H	■		
	63	S	■		
		H	■		
125	16	C			■
		S			■
	20	H			■
		R			■
	25	C			■
		S			■
	30	H			■
		R			■
	32	C			■
		S			■
	40	H			■
		R			■
	50	C			■
		S			■
	60	H			■
		R			■
	63	C			■
		S			■
75	H			■	
	R			■	

Calibre base del aparato	Corriente (A)	Código de poder de corte	Conexión frontal			
			Tornillo hexagonal (B)	Tornillo hexagonal (A)	Tornillo de cruz (C)	
80	80	C			■	
		S			■	
		H			■	
	100	R			■	
		C			■	
		S			■	
	125	H			■	
		R			■	
		C			■	
	125	100	S			■
			H			■
			R			■
125		C			■	
		S			■	
		H			■	
250		100	R			■
			C	■		
			S	■		
		125	H	■		
			R	■		
			C	■		
	140	S	■			
		H	■			
		R	■			
	150	C	■			
		S	■			
		H	■			
160	R	■				
	C	■				
	S	■				
175	H	■				
	R	■				
	C	■				
180	S	■				
	H	■				
	R	■				
200	C	■				
	S	■				
	H	■				
250	R	■				
	C	■				
	S	■				
225	H			■		
	R			■		
	S			■		
250	H			■		
	R			■		
	S			■		
300	H			■		
	R			■		
	S			■		

Calibre base del aparato	Corriente (A)	Código de poder de corte	Conexión frontal		
			Tornillo hexagonal (B)	Tornillo hexagonal (A)	Tornillo de cruz (C)
315		S		■	
		H		■	
		R		■	
400	350	S		■	
		H		■	
		R		■	
400	400	S		■	
		H		■	
		R		■	
400	400	S		■	
		H		■	
		R		■	
630	500	S		■	
		H		■	
		R		■	
630	630	S		■	
		H		■	
		R		■	
800	630	H	■		
		R	■		
		H	■		
800	700	H	■		
		R	■		
		H	■		
800	800	H	■		
		R	■		
		H	■		
1250	700	H	■		
		800	■		
		900	■		
		1000	■		
1250	1250	H	■		
		H	■		

Terminales de conexión

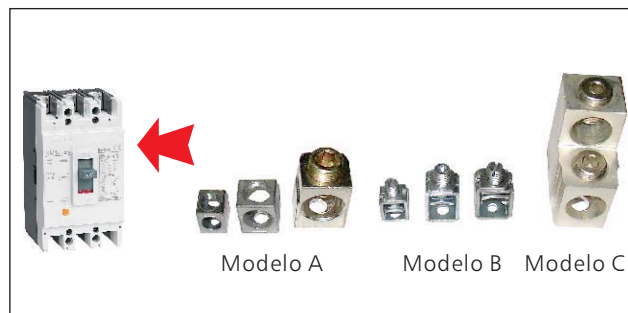

Conexión posterior

Conexión trasera disponible para interruptores de 3P y 4P
- NM1-63 a NM1-800



Conexión enchufable

Conexión enchufable disponible para interruptores de 3P y 4P
- NM1-63 a NM1-800

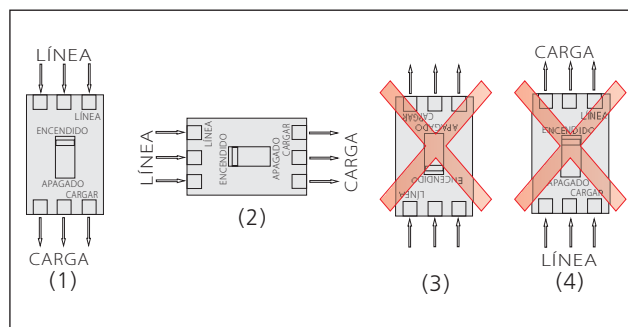

Los interruptores NM1 pueden ser conectados según se muestra en los dibujos (1) y (2). Puesto que el poder de corte del aparato puede verse afectado, el modo de conexión (3) no es recomendable sin el consentimiento y autorización de Chint. El modo de conexión (4) no está permitido para esta serie de interruptores.

10. Dimensiones generales y de montaje

Dimensiones generales y de montaje de NM1-63,100,225 (Tipos fijos)

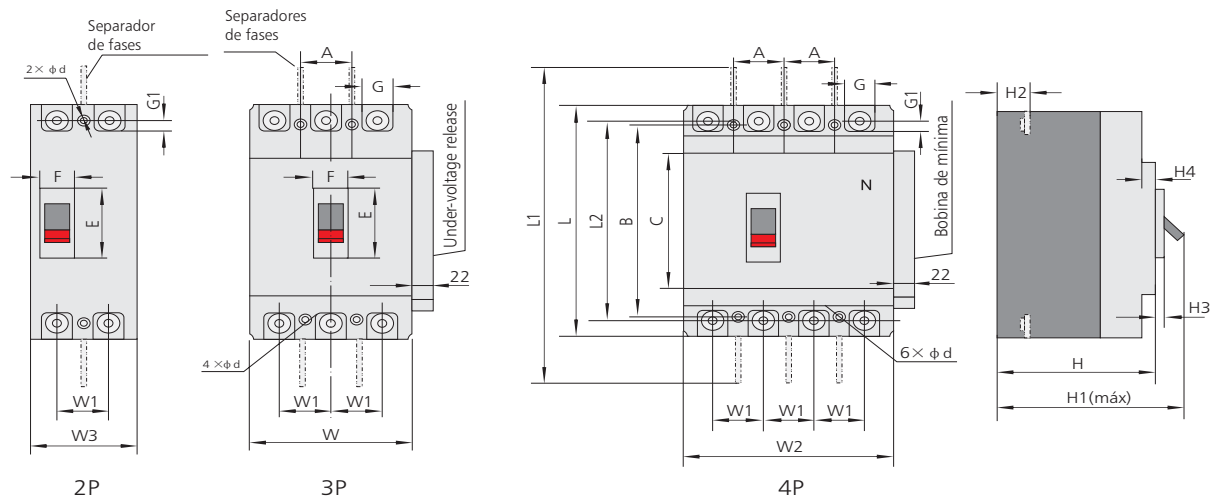

(mm)

Dimension	NM1-63S	NM1-63H	NM1-125C NM1-125S	NM1-125H NM1-125R	NM1-250C NM1-250S	NM1-250H NM1-250R
Dimensiones generales	C	85	85	84	102	102
	E	48	48	50.5	50.5	51
	F	22	22	22	22	22
	G	14	14	17.5	17.5	23
	G1	6.5	6.5	7.5	7.5	11.5
	H	72	82	67	87	86
	H1	90	100	84	103	110
	H2	18	28	24	24	24
	H3	4	4	4	4	4
	H4	6	6	7	7	5
	L	135	135	155	155	165
	L1	233	235	255	255	360
	L2	117	117	136	136	144
	W	76	76	90	90	105
	Dimensiones del montaje	W1	25	25	30	30
W2		-	102.5	-	120	-
W3		-	-	-	65	-
A	25	25	30	30	35	
B	117	117	130.5	130.5	126	
ϕd	4.5	4.5	4.5×6	4.5×6	5.5	

Dimensiones generales y de montaje de NM1-400, 630, 800, 1250(Modelo fijo)

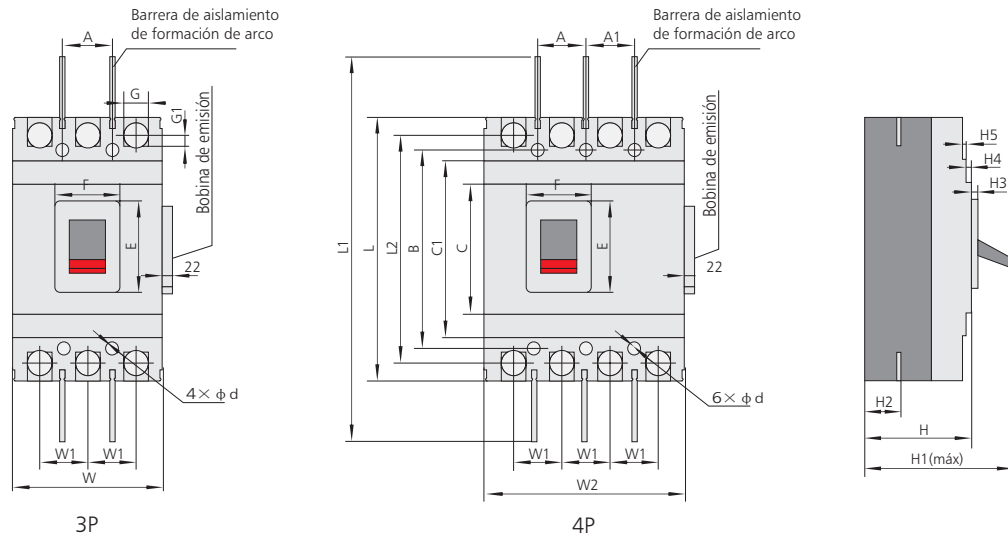

(mm)

Dimensiones	NM1-400S NM1-400H NM1-400R	NM1-630S NM1-630H NM1-630R	NM1-800H/R	NM1-1250H	
Dimensiones generales	C	127.5	134.5	136	265.5
	C1	173.5	184.5	204	345.5
	E	88.5	89	81	97
	F	65	65.5	66	78
	G	30.5	44	45	-
	G1	11	13.5	12.5	-
	H	107	112	116	141
	H1	162	164.5	168	202
	H2	40	42	41.5	58
	H3	6.5	7	4.5	16.5
	H4	5	3.5	5	2
	H5	5	4.5	8	4.5
	L	257	270.5	280	406*
	L1	457	470	485	715
	L2	224	234	243	-
	W	150	182	210	210
W1	48	58	70	70	
W2	197.5	240	280	-	
Dimensiones del montaje	A	44	58	70	70
	B	194	200	243	375
	φ d	7	7	7	10

*Nota: Longitud del NM1-1250H con el tablero de conexión, es 545mm

Dimensiones generales y de montaje de
 NM1-63, 100, 225(Modelo fijo)

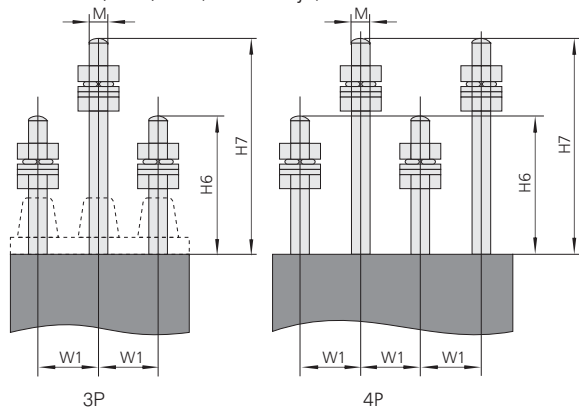

Dimensiones generales y de montaje de
 NM1-400, 630, 800(Modelo fijo)



Gráfico de perforación de la placa trasera



Modelo enchufable

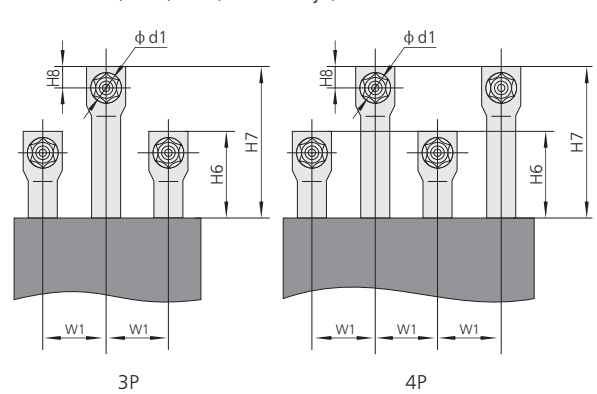
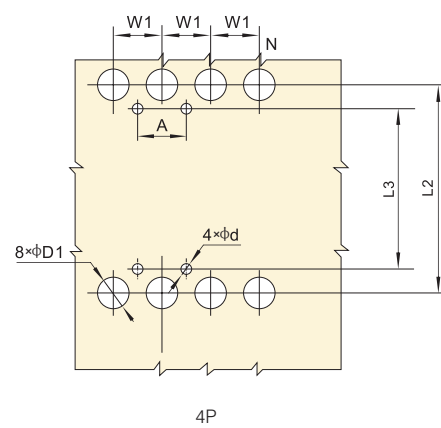
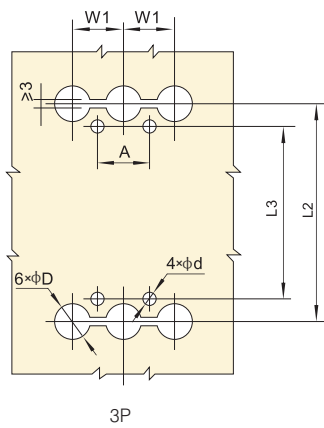

Gráfico de montaje 3P



Gráfico de perforación 3P de la placa de montaje

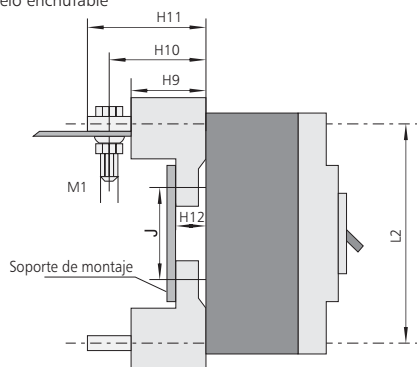

Gráfico de perforación 4P de la placa de montaje

(mm)

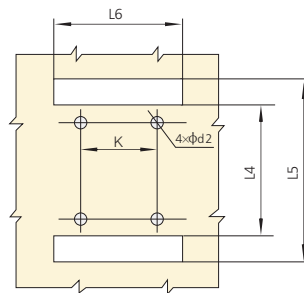
Dimensiones		NM1-63S NM1-63H	NM1-125S NM1-125H NM1-125R	NM1-250S NM1-250H NM1-250R	NM1-400S NM1-400H NM1-400R	NM1-630S NM1-630H NM1-630R	NM1-800H NM1-800R
Dimensiones de conexión trasera y modelo enchufable	A	25	30	35	44	58	70
	φ d	4.5	4.5×6	5.5	7	7	7
	φ d1	-	-	-	φ 12	φ 16	φ 16
	φ d2	6	8	8	9	9	12
	φ D	8	10	12	33	37	37
	φ D1	8	10	12	33	37	37
	H6	S:32 / H:23	63.5	67.5	39	45	64
	H7	S:47 / H:38	96.5	118.5	74	79	64
	H8	-	-	-	18	20	20
	H9	28	50	50	60	60	87
	H10	38	67.5	71.5	88	92	143.5
	H11	44.5	81	84.5	111	110	158.7
	H12	10	18	18	21.5	21	27
	L2	117	136	144	224	234	243
	L3	117	130.5	126	194	200	243
	L4	97	93	93	163	165	173
	L5	138	180	190	285	302	305
	L6	80/105*	95/125*	110/140*	150/198*	180/238*	215/285*
	M	M6	M8	M10	-	-	-
	K	50	60	70	60	100	90
K1	25	30	35	66	66	95	
J	60	58	54	130.4	124	146	
M1	M5	M8	M8	M10	M12	M12	
W1	25	30	35	48	58	70	
W2	12.5	15	17.5	24	29	35	

Nota: El "*" representa la dimensión del interruptor 4p

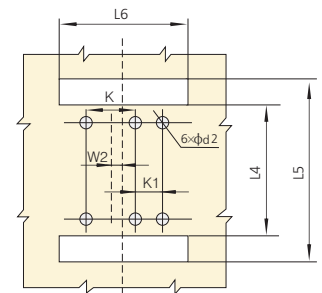
11. Accesorios

Accesorios internos

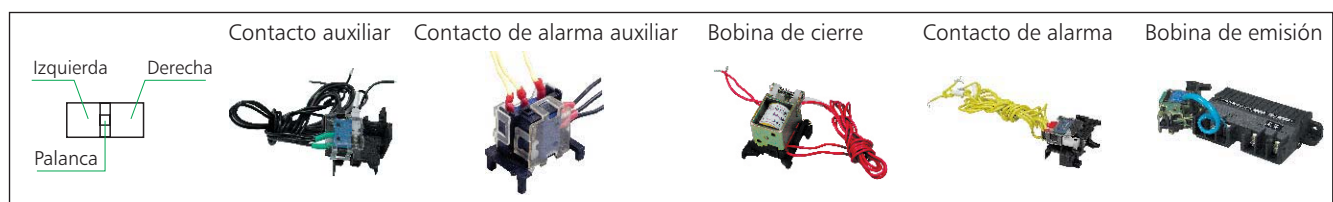

Con accesorio	Código de accesorio		Modo de montaje y conexiones				
	Disparador sólo magnético	Disparador compuesto	NM1-63S NM1-125C,S,H,R NM1-250C,S,H,R	NM1-63S,H NM1-125C,S,H,R NM1-250C,S,H,R NM1-400S,H,R	NM1-630S,H,R	NM1-800H, R	NM1-1250H
			2P	3P 4P	3P 4P	3P 4P	3P
Sin accesorio	200	300					
Contacto de alarma	208	308					
Bobina de cierre	210	310					
Contacto auxiliar	220	320					
Bobina de emisión	230	330					
Bobina de cierre, contacto auxiliar	240	340					
Bobina de cierre, bobina de emisión	250	350					
Dos grupos de contactos auxiliares	260	360					
Contacto auxiliar, bobina de emisión	270	370					
Bobina de cierre, contacto de alarma	218	318					
Contacto de alarma auxiliar	228	328					
Bobina de emisión, contacto de alarma	238	338					
Bobina de cierre, contacto auxiliar	248	348					
Dos grupos de contacto auxiliar del contacto de alarma auxiliar	268	368					
Bobina de emisión, contacto de alarma auxiliar	278	378					

11.1 Bobina de emisión

- a. $U_n=70\sim 35\% U_s$, funcionamiento seguro
- b. $U_n=<35\% U_s$, evita que el interruptor haga conexión
- c. $U_n=>85\% U_s$, funcionamiento seguro

La tensión nominal de la bobina de emisión es 50Hz, 230V y 400V.

Código de bobina de emisión

Código	A2	A4	D1	D2
Tensión	230Vca	400Vca	110Vcc	220Vcc
Frecuencia nominal	50Hz	50Hz	-	-

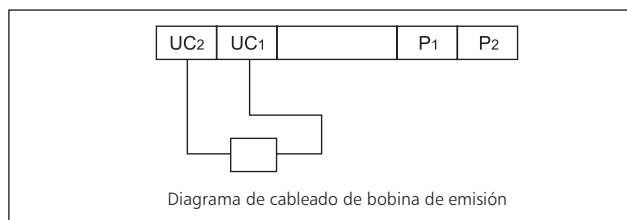

11.2 Bobina de cierre

La tensión de control nominal de la bobina de cierre es 50Hz, 230V y 400V.

$U_n=70\% \sim 110\% U_s$, funcionamiento seguro

Código de bobina de cierre

Código	A1	A2	A4	D1	D2	D3
Tensión	110/127Vca	230Vca	400Vca	110Vcc	220Vcc	24Vcc
Frecuencia nominal	50Hz	50Hz/ 60Hz	50Hz/ 60Hz	-	-	-

Nota: si la tensión es 24Vcc, la corriente nominal debería ser de $5A \pm 10\%$

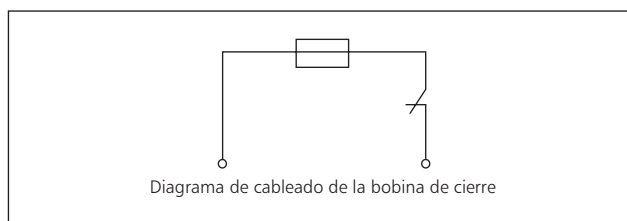

11.3 Contacto auxiliar y parámetro máximo de contacto de alarma del contacto auxiliar

Tamaño de marco	Corriente de calentamiento convencional I_{th} (A)	Corriente nominal I_e (A) a 400 Vca	Corriente nominal I_e (A) a 230 Vcc
$I_{nm} \leq 225A$	3	0.26	0.14
$I_{nm} \geq 400A$	6	3	0.2

a. Contacto auxiliar

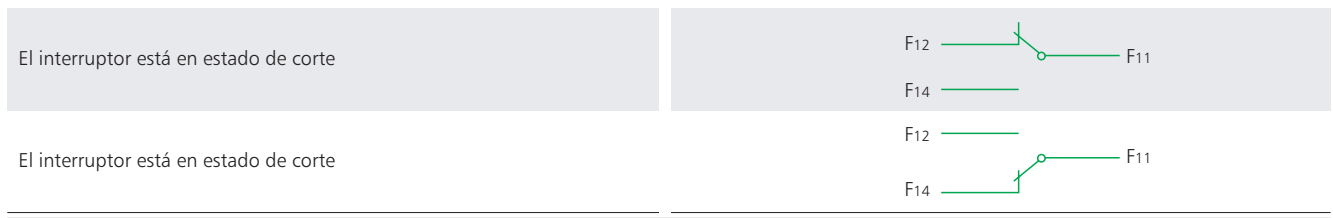

b. Contacto de alarma

Cuando el interruptor conecta y corta, el contacto de alarma no funciona. Tras la activación del contacto de alarma de disparo libre (o disparo por fallo) y después de que el interruptor vuelva a funcionar, el contacto de alarma volverá a su estado original.

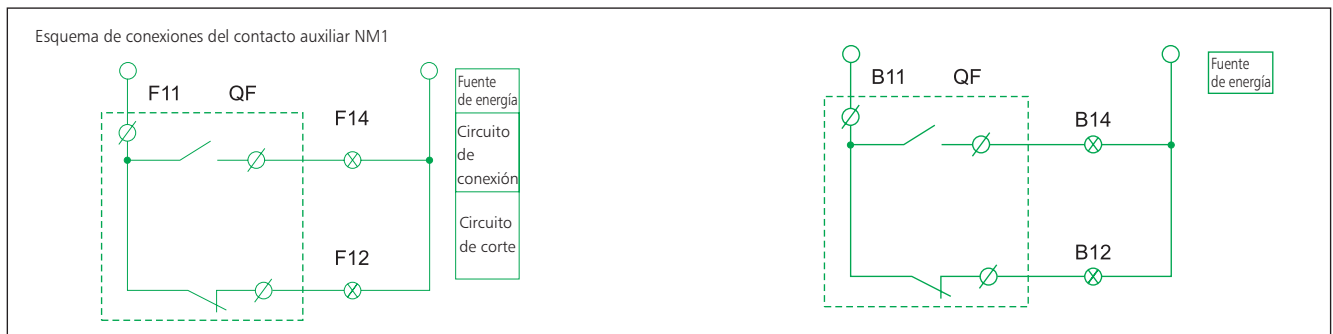
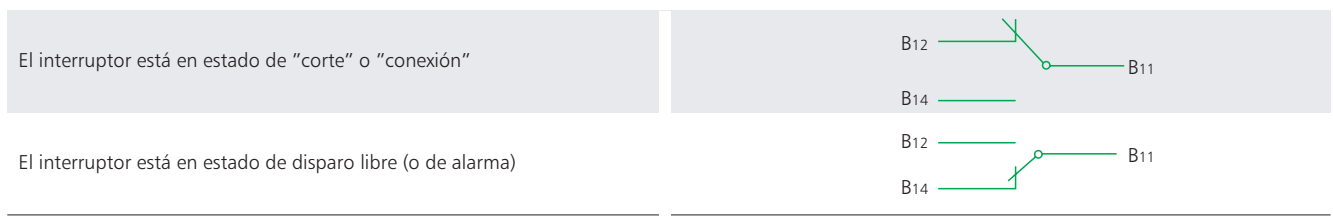

Accesorios externos

11.4 Mecanismo de accionamiento motorizado

Objetos	Modelo	NM1-63 NM1-125, NM1-250, NM1-400, NM1-630, NM1-800, NM1-1250
Structure form		Sistema electromagnético Motor
Code of CA/CC voltage		A1/D1, A2/D2, A4, D3

Nota: A1 CA 110V, A2 CA 230V, A4 CA 400V, D1 CC 110V, D2 CC 220V, D3 CC 24V,

Gráfico de conexión/corte del mecanismo de accionamiento motorizado (CA) de NM1-400, 630, 800, 1250

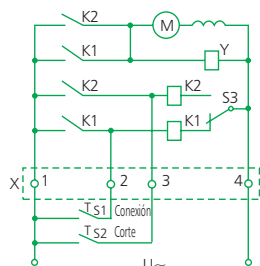

Con relé de cierre automático

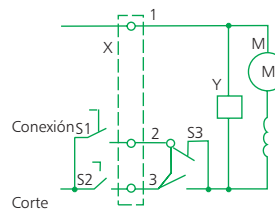

Sin relé de cierre automático

Especificación 50Hz ca 230V o 400V

Mecanismo de funcionamiento manual giratorio

Gráfico de conexión/corte del dispositivo manual

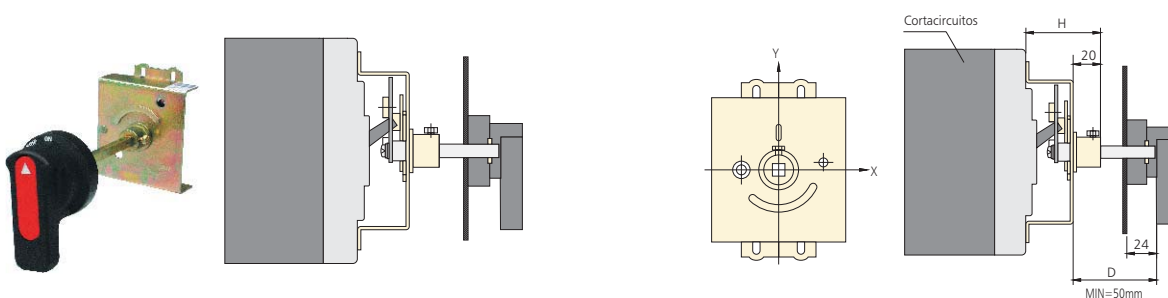

Dimensiones de montaje del dispositivo manual



Gráfico de perforación del montaje de la palanca



(mm)

Modelo	NM1-63	NM1-125	NM1-250	NM1-400	NM1-630	NM1-800H NM1-800R
Tamaño de montaje	49	51	54	88	89	76
El valor Y de la palanca hace referencia al centro del interruptor	0	0	0	0	0	0

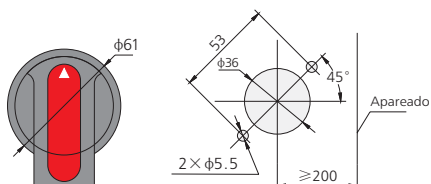
Dimensiones de montaje y perforación

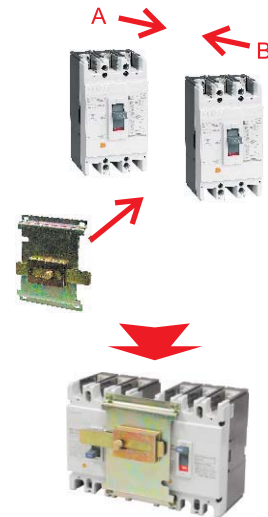
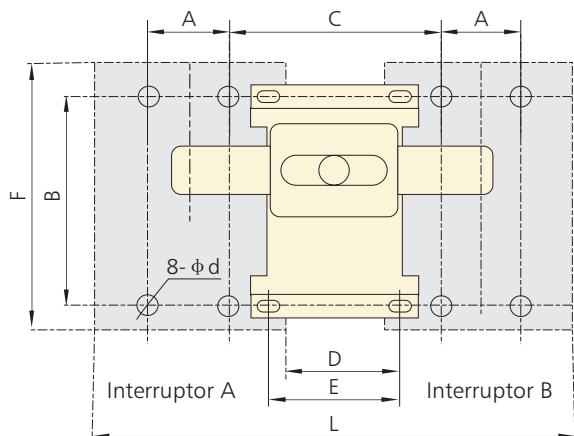

(mm)

Modelo	A	B	C	D	E	F	L	Φd
NM1-63	25	117	80	30	80	135	182	4.5
NM1-100	30	130.5	90	30	90	155	210	4.5×6*
NM1-225	35	126	100	30	100	165	240	5.5
NM1-400	44	194	136	30	40	257	330	7
NM1-630	58	200	172	48	62	270	412	7
NM1-800	70	243	167	28	40	280	448	7

Nota:

- * representa la longitud de perforación.
- Instale el interruptor sobre el marco primero y después el cerrojo mecánico sobre el interruptor.

12. Información técnica adicional

- Para los productos personalizados de NM1-225, es posible aumentar la capacidad a 250A.
- Los productos NM1-1250 están equipados con placas de conexión en el momento de su venta. Si necesita una placa de conexión para productos de otro modelo, deberá hacer el pedido por separado.
- Sólo el interruptor modelo H es apto para fabricar el seccionador de la serie NM1.
- Existen cubiertas de terminales para todos los productos de la serie NM1. El grado de protección puede alcanzar Ip40 una vez que el producto es equipado con el cubrebombes.

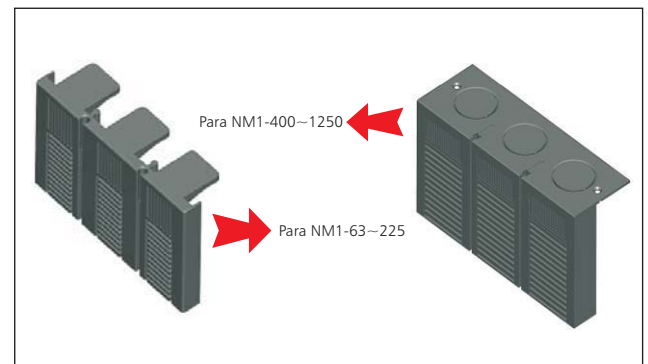

12.5 Distancia de seguridad entre dispositivos eléctricos a tener en cuenta en el montaje

(mm)

Distancia (min.) / Modelo	NM1-63	NM1-100	NM1-225	NM1-400	NM1-630	NM1-800	NM1-1250
Lado de línea	50	50	50	100	100	100	100
Lado de carga	20	20	20	20	20	20	20
Lado derecho	25	25	25	25	25	25	25
Lado izquierdo	25	25	25	25	25	25	25

12.6 Tabla de pares de torsión

Tamaño del cable (cobre)		Corriente nominal (A)	Par de torsión ajustable (N · m)	
AWG/MCM	mm ²		Pletina frontal	Terminal de encaillamiento
16-6	1.5-16	10 ≤ In ≤ 63	5	3
4-3	25-35	63 < In ≤ 100	10	8
2-4/0	50-95	100 < In ≤ 225	14	10
300-500	120-240	225 < In ≤ 400	18	16
250×2	150×2	400 < In ≤ 500	22	18
350×2	185×2	500 < In ≤ 630	26	20
500×2	240×2	630 < In ≤ 800	28	-
350×4	185×4	800 < In ≤ 1250	30	-

12.7 Datos técnicos de la serie NM1

Corriente de marco (A)	Modelo	Número de polos	Ui (V)	Icu/Ics(kA)				
				220V 240V	380V 415V	440V	480V 500V	660V 690V
63	NM1-63S	2	500	20/10	15/7.5	-	-	-
		3	500	20/10	15/7.5	10/5	-	-
	NM1-63H	3/4	500	42/21	35/17.5	20/10	-	-
125	NM1-125C	2	800	25/12.5	20/10	-	-	-
		3/4	800	25/12.5	20/10	15/7.5	10/5	3/1.5
	NM1-125S	2	800	42/21	25/12.5	-	-	-
		3/4	800	42/21	25/12.5	20/10	10/5	3/1.5
	NM1-125H	2	800	65/32.5	50/25	-	-	-
		3/4	800	65/32.5	50/25	42/21	25/12.5	8/4
NM1-125R	2	800	85/42.5	65/32.5	-	-	-	
	3/4	800	85/42.5	65/32.5	55/27.5	35/17.5	10/5	
250	NM1-250C	2	800	25/12.5	20/10	-	-	-
		3/4	800	25/12.5	20/10	15/7.5	10/5	5/2.5
	NM1-250S	1	800	20/10	-	-	-	-
		2	800	42/21	25/12.5	-	-	-
	3/4	800	42/21	25/12.5	20/10	10/5	5/2.5	
		NM1-250H	2	800	65/32.5	50/25	-	-
3/4	800		65/32.5	50/25	42/21	25/12.5	8/4	
NM1-250R	2	800	85/42.5	65/32.5	-	-	-	
	3/4	800	85/42.5	65/32.5	55/27.5	35/17.5	10/5	
400	NM1-400S	3/4	800	50/25	35/17.5	30/15	15/7.5	10/5
		3/4	800	85/42.5	50/25	42/21	25/12.5	12/6
	NM1-400R	3/4	800	100/50	70/35	65/32.5	42/21	15/7.5
630	NM1-630S	3/4	800	50/25	35/17.5	30/15	15/7.5	12/6
		3/4	800	85/42.5	50/25	42/21	25/12.5	15/7.5
	NM1-630R	3/4	800	100/50	70/35	65/32.5	40/20	20/10
800	NM1-800H	3/4	800	85/42.5	60/30	55/27.5	30/15	20/10
		3/4	800	100/50	70/35	65/32.5	40/20	20/10
1250	NM1-1250H	3	800	85/42.5	65/32.5	55/27.5	30/15	20/10

Corriente de marco (A)	Modelo	Número de polos	Ui (V)	Icu/Icm(kA)				
				220V 240V	380V 415V	440V	480V 500V	660V 690V
63	NM1-63S	2	500	20/40	15/30	-	-	-
		3	500	20/40	15/30	10/17	-	-
	NM1-63H	3/4	500	42/88.2	35/73.5	20/40	-	-
125	NM1-125C	2	800	25/52.5	20/40	-	-	-
		3/4	800	25/52.5	20/40	15/30	-	-
	NM1-125S	2	800	42/88.2	25/52.5	-	-	-
		3/4	800	42/88.2	25/52.5	20/40	-	-
	NM1-125H	2	800	65/43	50/105	-	-	-
		3/4	800	65/43	50/105	42/88.2	-	-
NM1-125R	2	800	85/187	65/143	-	-	-	
	3/4	800	85/187	65/143	55/121	-	-	
250	NM1-250C	2	800	25/52.5	20/40	-	-	-
		3/4	800	25/52.5	20/40	15/30	-	-
	NM1-250S	1	800	20/40	-	-	-	-
		2	800	42/88.2	25/52.5	-	-	-
	3/4	800	42/88.2	25/52.5	20/40	-	-	
		NM1-250H	2	800	65/43	50/105	-	-
	3/4		800	65/43	50/105	42/88.2	-	-
	NM1-250R	2	800	85/187	65/143	-	-	-
3/4		800	85/187	65/143	55/121	-	-	
400	NM1-400S	3/4	800	50/105	35/73.5	30/63	-	-
		3/4	800	85/187	50/105	42/88.2	-	-
	NM1-400R	3/4	800	100/220	70/154	65/143	-	-
630	NM1-630S	3/4	800	50/105	35/73.5	30/63	-	-
		3/4	800	85/187	50/105	42/88.2	-	-
	NM1-630R	3/4	800	100/220	70/154	65/43	-	-
800	NM1-800H	3/4	800	85/187	60/132	55/121	-	-
		3/4	800	100/220	70/154	65/143	-	-
1250	NM1-1250H	3	800	85/187	65/143	55/121	-	-

Nota: Los parámetros en negro son sólo de referencia.

12.8 Cascada

12.8.1 Cascada (220/230/240V)

Subida: NM1-63~1250

Bajada: DZ47, eB, UB, DZ158, DZ267, NB1, NBH8, NM1-63~1250

Subida Poder de corte (kA RMS) →	NM1-63S 20	NM1-63H 42	NM1-125S 25	NM1-125H 50	NM1-125R 65	NM1-250S 25	NM1-250H 50	
Bajada ↓	Poder de corte (kA RMS)							
DZ267	20	40	20	35	50	20	25	
DZ47, eB, UB	20	40	20	35	50	20	25	
NBH8	20	40	20	35	50	20	25	
NB1(Icn=6000A)	20	42	25	35	50	25	35	
NB1(Icn=10000A)	20	42	25	40	50	25	35	
DZ158			25	40	50	25	40	
NM1-63S		42	25	50	65	25	50	
NM1-63H					65			
NM1-125S				50	65		50	
NM1-125H					65			
NM1-250S							50	
NM1-250H								
NM1-400S								
NM1-400H								
NM1-630S								
NM1-630H								
NM1-800H								
NM1-1250H								
	DZ47, eB, UB, DZ158, DZ267, NB1, NBH8, NM1-63~1250							

12.8.2 Cascada (380/400/415V)

Subida: NM1-63~1250

Bajada: DZ47, eB, UB, DZ158, DZ267, NB1, NBH8, NM1-63~1250

Subida Poder de corte (kA RMS) →	NM1-63S 15	NM1-63H 35	NM1-125S 25	NM1-125H 50	NM1-125R 65	NM1-250S 25	NM1-250H 50	
Bajada ↓	Poder de corte (kA RMS)							
DZ47, eB, UB	10	15	10	15	15	10	15	
NB1(Icn=6000A)	15	20	15	20	20	15	20	
NB1(Icn=10000A)	15	20	20	25	25	20	25	
DZ158			20	25	35	20	25	
NM1-63S		35	25	50	65	25	50	
NM1-63H					65			
NM1-125S				50	65		50	
NM1-125H					65			
NM1-250S							50	
NM1-250H								
NM1-400S								
NM1-400H								
NM1-630S								
NM1-630H								
NM1-800H								
NM1-1250H								

NM1-250R 65	NM1-400S 35	NM1-400H 50	NM1-400R 70	NM1-630S 35	NM1-630H 50	NM1-630R 70	NM1-800H 60	NM1-800R 70	NM1-1250H 65
30									
30									
30									
35									
40									
50	30	40	50						
65									
65									
65		50	70		50	70	60	70	65
65			70			70		70	
65		50	70		50	70	60	70	65
65			70			70		70	
		50	70		50	70	60	70	65
			70			70		70	
					50	70			
						70			
								70	

NM1-250R 65	NM1-400S 35	NM1-400H 50	NM1-400R 70	NM1-630S 35	NM1-630H 50	NM1-630R 70	NM1-800H 60	NM1-800R 70	NM1-1250H 65
15									
20									
25									
35	20	25	35						
65									
65									
65		50	70		50	70	60	70	65
65			70			70		70	
65		50	70		50	70	60	70	65
65			70			70		70	
		50	70		50	70	60	70	65
			70			70		70	
					50	70			
						70			
								70	